

10. FINAL REDUCTION

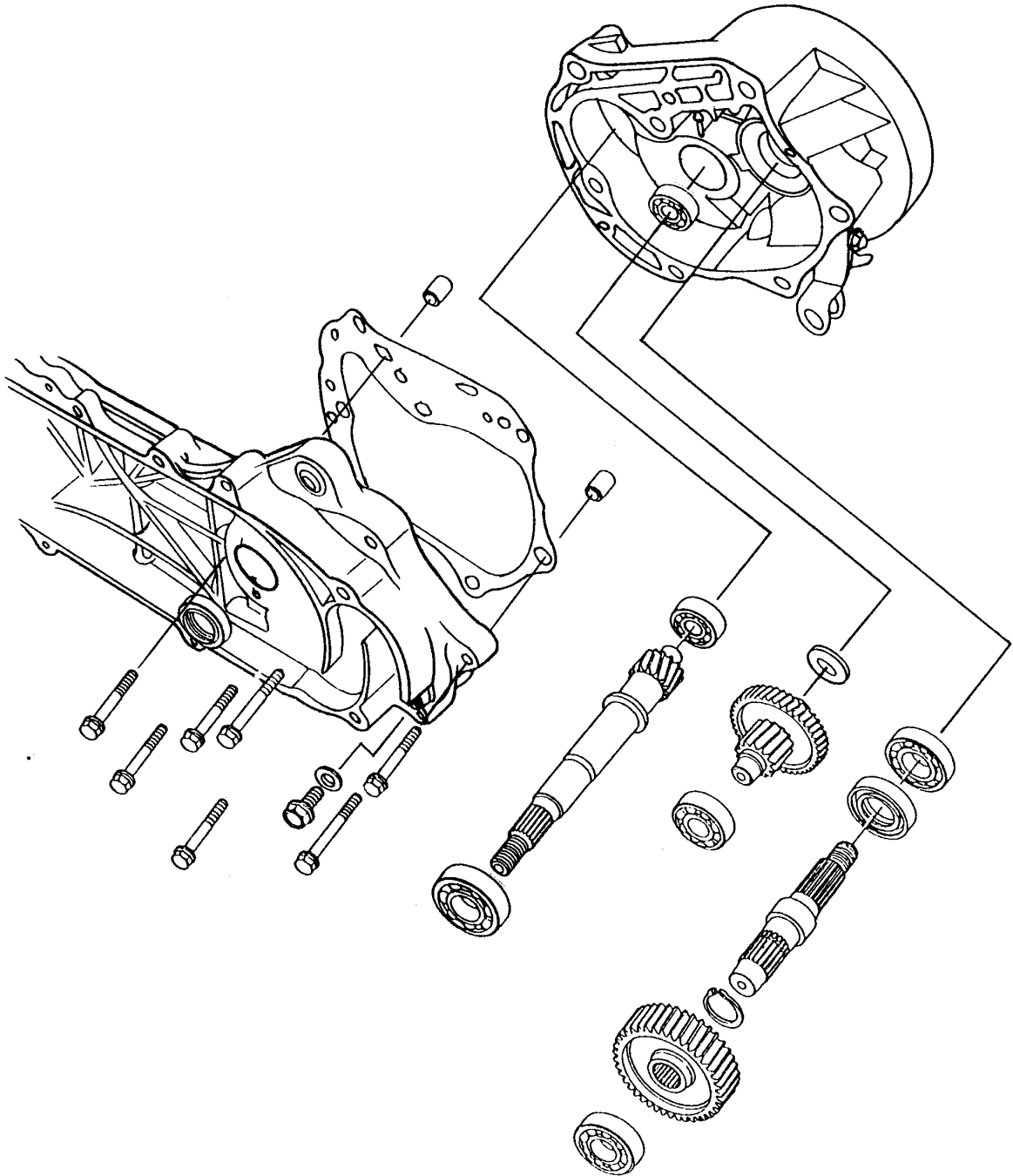

10

10. FINAL REDUCTION

SERVICE INFORMATION	10-1	FINAL REDUCTION INSPECTION.....	10-2
TROUBLESHOOTING.....	10-1	BEARING REPLACEMENT	10-3
FINAL REDUCTION DISASSEMBLY	10-2	FINAL REDUCTION ASSEMBLY.....	10-4

SERVICE INFORMATION

SPECIFICATIONS

Specified Oil: GEAR OIL SAE 90#

Oil Capacity: At disassembly : 0.11 liter
 At change : 0.10 liter

SPECIAL TOOLS

Bearing puller, 10,12,15,18mm

TROUBLESHOOTING

Engine starts but motorcycle won't move

- Damaged transmission
- Seized or burnt transmission
- Faulty drive belt
- Faulty clutch

Abnormal noise

- Worn, seized or chipped gears
- Worn bearing

Oil leaks

- Oil level too high
- Worn or damaged oil seal

10. FINAL REDUCTION

FINAL REDUCTION DISASSEMBLY

- Remove the rear brake cable. (⇒13-3)
- Remove the rear wheel. (⇒13-2)
- Remove the left crankcase cover. (⇒9-2)
- Remove the clutch/driven pulley. (⇒9-10)
- Drain the transmission gear oil into a clean container.
- Remove the transmission case cover attaching bolts.
- Remove the transmission case cover.
- Remove the gasket and dowel pins.

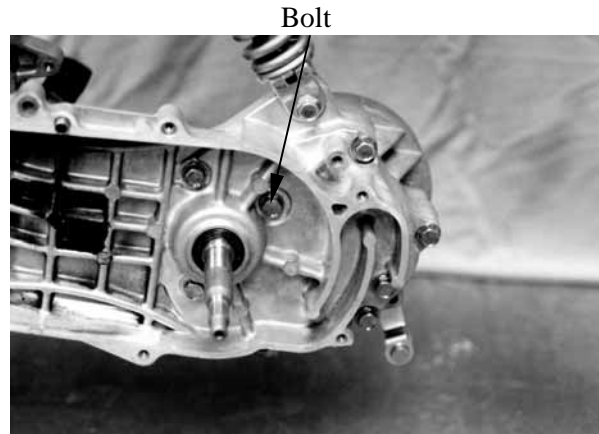

Remove the final gear and countershaft.

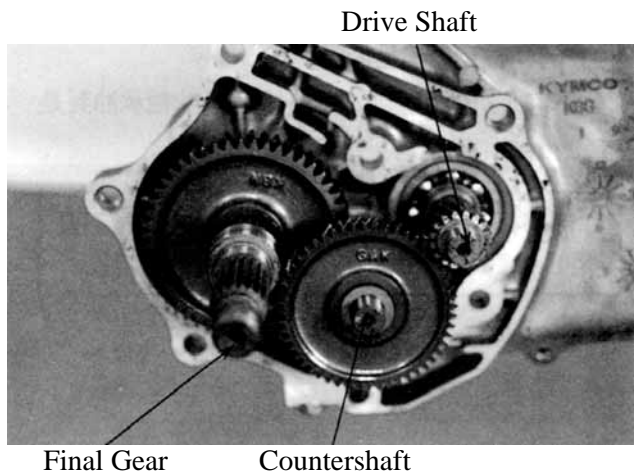

FINAL REDUCTION INSPECTION

Inspect the countershaft and gear for wear or damage.

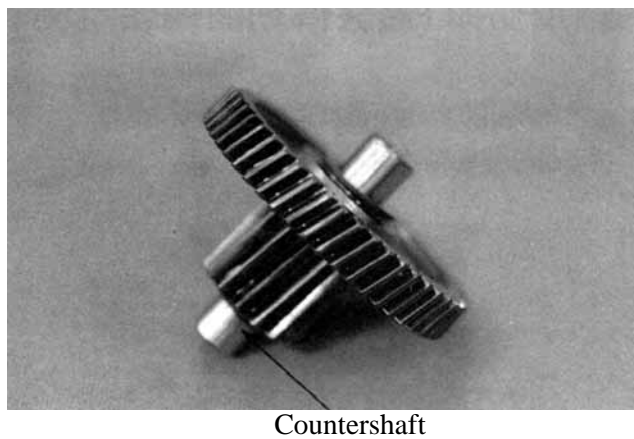

Inspect the final gear and final shaft for wear, damage or seizure.

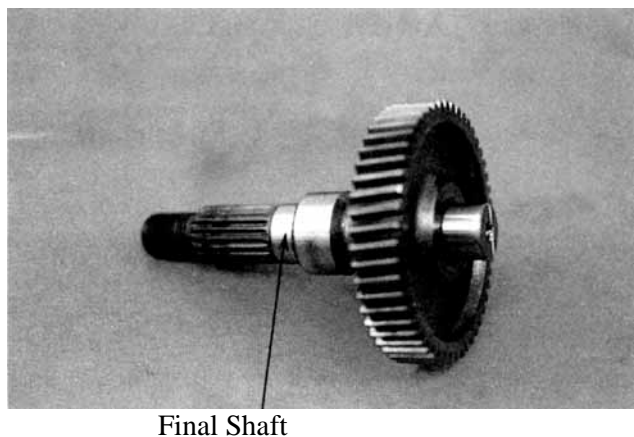

10. FINAL REDUCTION

Check the left crankcase bearings for excessive play and inspect the oil seal for wear or damage.

Drive Shaft Bearing

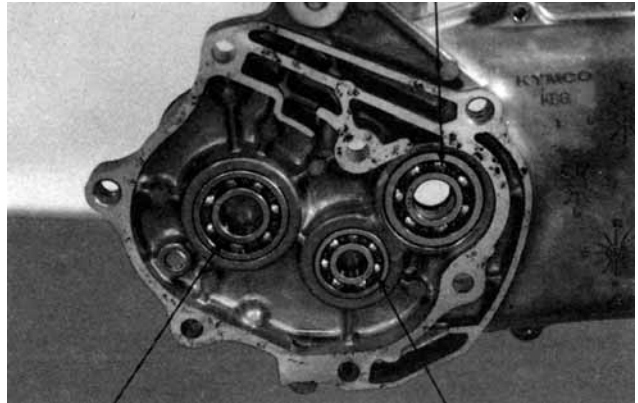

Final Shaft Bearing

Countershaft Bearing

Inspect the drive shaft and gear for wear or damage. Check the transmission case cover bearings for excessive play and inspect the final shaft bearing oil seal for wear or damage.

★

Do not remove the transmission case cover except for necessary part replacement. When replacing the drive shaft, also replace the bearing and oil seal.

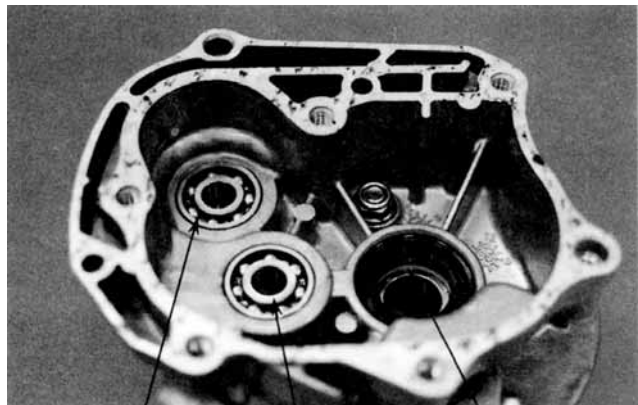

Countershaft Bearing Drive Shaft Bearing Oil Seal

Final Shaft Bearing

BEARING REPLACEMENT (TRANSMISSION CASE COVER)

Remove the transmission case cover bearings using a bearing puller. Remove the final shaft oil seal.

Special

Bearing Puller

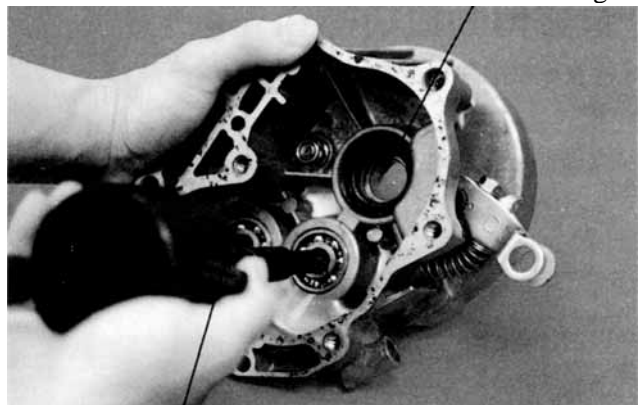

Bearing Puller

Drive new bearings into the transmission case cover.



Outer Driver, 32x35mm

10. FINAL REDUCTION

BEARING REPLACEMENT (LEFT CRANKCASE)

Remove the drive shaft.
Remove the drive shaft oil seal.
Remove the left crankcase bearings using a bearing puller.

Special

Bearing Puller

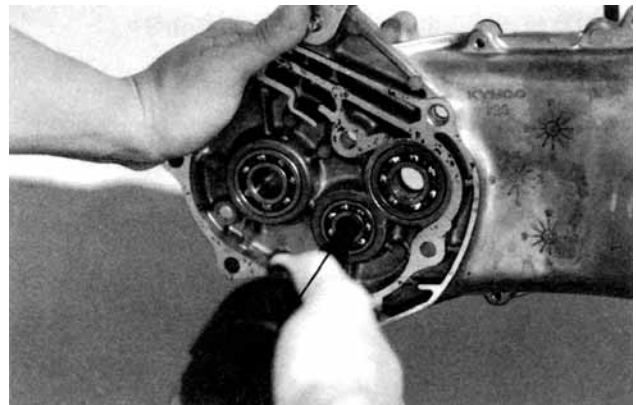

Bearing Puller, 12mm

Drive new bearings into the left crankcase.
Install a new drive shaft oil seal.

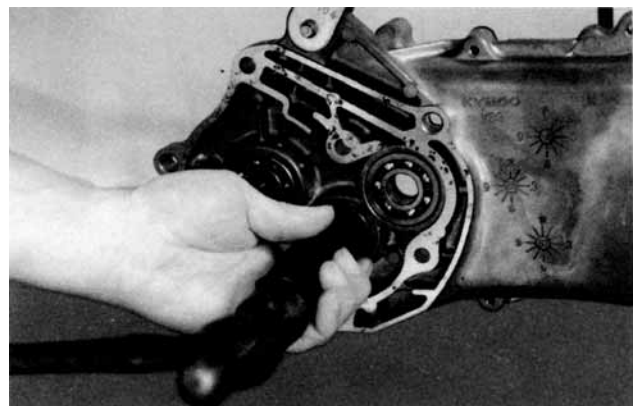

Pilot

FINAL REDUCTION ASSEMBLY

Install the drive shaft into the left crankcase.

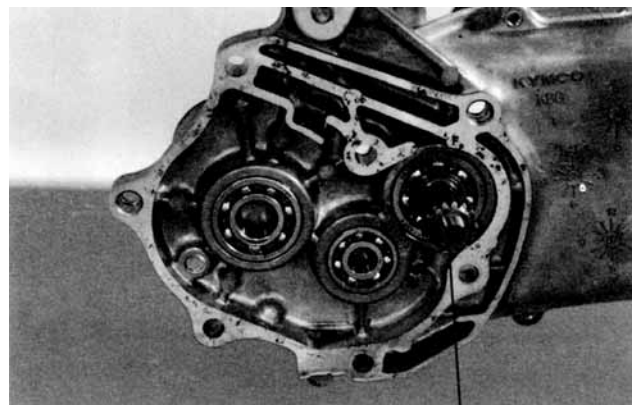

Drive Shaft

Install the final gear and final shaft into the left crankcase.

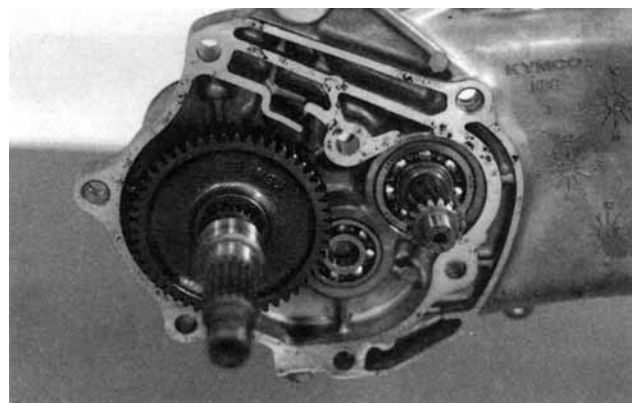

10. FINAL REDUCTION

AGILITY 50

Install the countershaft and gear into the left crankcase.
 Install the resin washer onto the countershaft.
 Install the dowel pins and a new gasket.

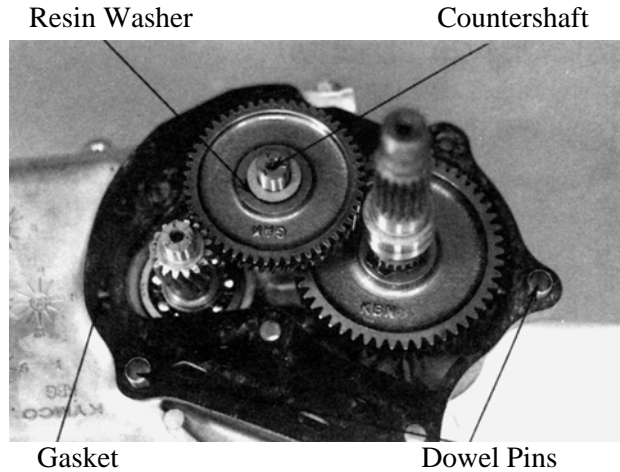

Install the transmission case cover.

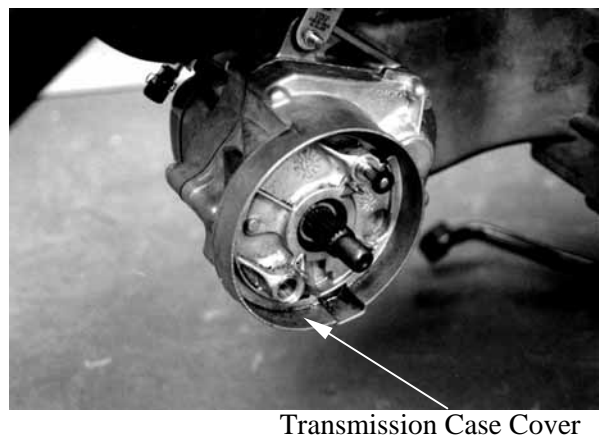

Install and tighten the transmission case cover bolts.
 Install the clutch/driven pulley. (⇒9-13)

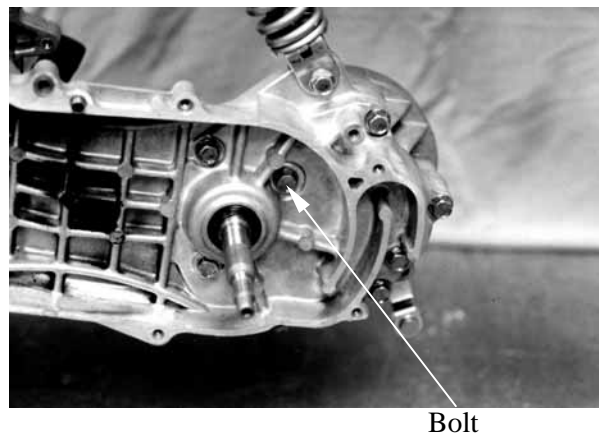

After installation, fill the transmission case with the specified oil. (⇒3-7)

- ★
- Place the motorcycle on its main stand on level ground.
 - Check the oil sealing washer for wear or damage.

Specified Gear Oil: SAE90#

Oil Capacity:

- At disassembly : 0.11 liter
- At change : 0.10 liter

Install and tighten the oil check bolt.

Torque: 0.8~1.2kgf-m

Start the engine and check for oil leaks.
 Check the oil level from the oil check bolt hole and add the specified oil to the proper level if the oil level is low.

